

LED Tail Lights - Model 234

PRODUCT INFORMATION

Description	12-24V DOT LED Heated Amber Turn Signal
Height	20.28 mm / 0.8 in
Width	110.14 mm / 4.34 in
Depth	39.53 mm / 1.56 in
Shape	Round
Outer Lens Material	Polycarbonate
Outer Lens Color	Clear
Housing Material	Polycarbonate
Housing Color	Black
Bezel Color	Amber
Mounting Type	Grommet
Connector or Wiring	Bare Leads
Mating Connector	None. 3-Pin AMP Connector (#282087-1) sold separately.
Product Weight	0.31 lbs / 0.14 kgs
Shipping Weight	0.48 lbs / 0.22 kgs



Print date: 2024-08-11

© 2024 J.W. Speaker Corporation • Germantown, WI U.S.A.
www.jwspeaker.com • speaker@jwspeaker.com • 262.251.6660

J.W. SPEAKER 
Engineered. Lighting. Solutions.

LED Tail Lights - Model 234

PRODUCT DIMENSIONS

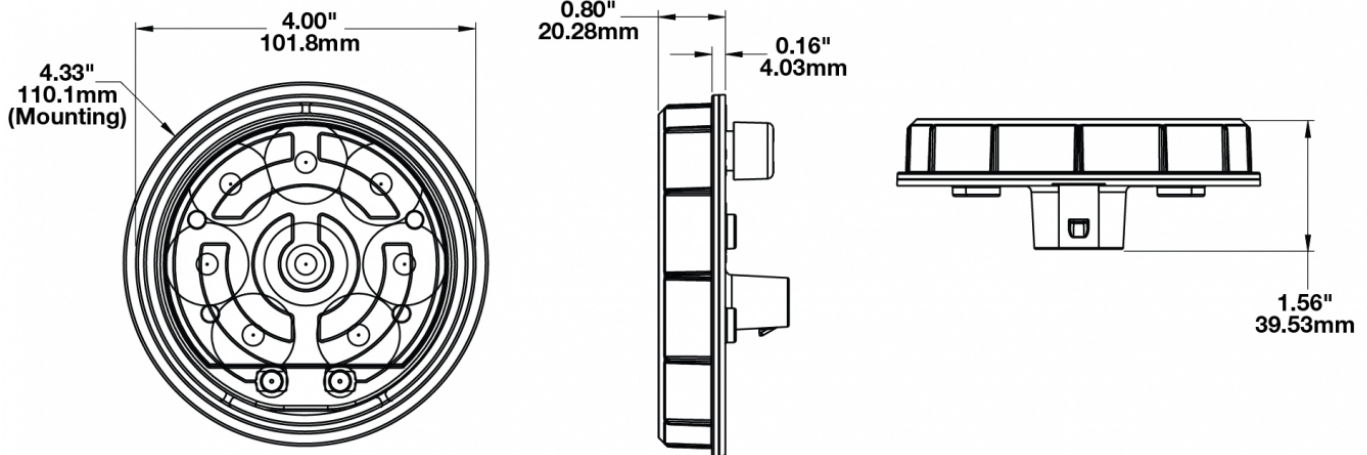

Pin Out Information

LIGHT (Socket shown ↑ top)

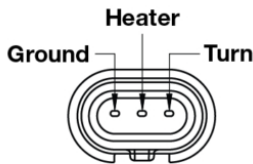

WIRE HARNESS*

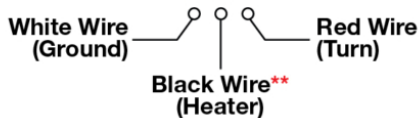

*Wire harness sold separately on Part # 0348711.
Wire harness included on Part # 0348714.
Also available as a single accessory (Part # 3270501)

**To operate heating circuit on the Turn Signal Lamp, a separate constant 12V DC power line must be wired.

ELECTRICAL SPECIFICATIONS

Input Voltage	12-24V DC
Operating Voltage	10-32V DC
Current Draw	.40A @ 12V DC (Turn) .20A @ 24V DC (Turn) 1.3A @ 12V DC (Turn Heated) .70A @ 24V DC (Turn Heated) .80A @ 12V DC (Heater) .40A @ 24V DC (Heater)

Print date: 2024-08-11

© 2024 J.W. Speaker Corporation • Germantown, WI U.S.A.
www.jwspeaker.com • speaker@jwspeaker.com • 262.251.6660

LED Tail Lights - Model 234

REGULATORY STANDARDS COMPLIANCE

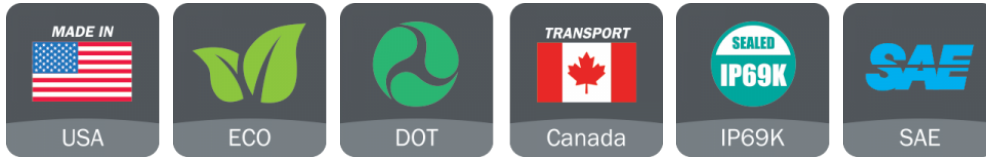

Buy America Standards Eco Friendly
FMVSS 108 s7.1 (Table VII) IEC IP69K
SAE J588

PHOTOMETRIC SPECIFICATIONS

Effective Lumen Output 7
Beam Pattern(s) Signalization - Tail

APPLICATIONS



INSTALLATION & APPLICATION INFORMATION

Installation requires the white wire (Heater) to be powered in order for the heater to work. If power is not supplied to the heater, the light will not be heated. Current Draws will differ based upon whether or not the heater is active. Turn off power before installing.

Print date: 2024-08-11

© 2024 J.W. Speaker Corporation • Germantown, WI U.S.A.
www.jwspeaker.com • speaker@jwspeaker.com • 262.251.6660



LED Tail Lights - Model 234

SMARTHEAT™ HEATING SYSTEM

The SmartHeat™ heating system senses ambient temperature and turns the integrated heating system in the lens on & off. This system actually clears ice & snow twice as fast as conventional halogen lamps.

When does the heater turn on?

Heater turns on or off according to temperature changes and vehicle power:

- Heater will turn on when temperatures drop, generating enough heat to prevent ice build-up.
- Heater will turn on when powering up, de-icing the light as rapidly as possible.

When does the heater turn off?

Heater will turn off when it senses temperatures increase and are above the high temperature threshold.

Learn more about this technology [here](#).

See Additional Information on page 1 for heated wire installation

PRODUCT WARNINGS

For California residents:

⚠ **WARNING:** Cancer and reproductive harm - www.P65Warnings.ca.gov.

⚠ **AVERTISSEMENT:** Cancer et effet nocif sur la reproduction - www.P65Warnings.ca.gov.

ACCESSORIES



Part Number
4242731
4" Round Rubber
Mounting Grommet for
Model 234



Part Number
5869401
4" Round Plastic
Mounting Flange for
Model 234



Part Number
8200441
4" Round Stainless
Steel Trim Ring for
Model 234



Part Number
8200451
4" Round Chrome
Plastic Trim Ring for
Model 234



Part Number
3270501
3-Pin AMP Connector
Wire Harness
Assembly

Print date: 2024-08-11

© 2024 J.W. Speaker Corporation • Germantown, WI U.S.A.
www.jwspeaker.com • speaker@jwspeaker.com • 262.251.6660

J.W. SPEAKER
Engineered. Lighting. Solutions.

LED Tail Lights - Model 234

RELATED PRODUCTS



Part Number
0346261
12-24V DOT LED
Heated Red Stop, Tail,
& Turn Light



Part Number
0346264
12-24V DOT LED
Heated Red Stop, Tail,
& Turn Light Kit with
Harness



Part Number
0346421
12-48V DOT LED Non-
Heated Stop & Tail
Light



Part Number
0346471
12-24V DOT LED
Heated White Reverse
Light



Part Number
0346474
12-24V DOT LED
Heated White Reverse
Light Kit with Harness



Part Number
0347814
12-24V DOT LED
Non-Heated Amber Turn
Signal Kit with Harness



Part Number
0347861
12-24V DOT LED Non-
Heated Red Stop, Tail,
& Turn Light



Part Number
0347864
12-24V DOT LED Non-
Heated Red Stop, Tail,
& Turn Light Kit with
Harness